

STANDARD BUILD IS FULL STAINLESS STEEL CONSTRUCTION.
PLEASE INQUIRE FOR CUSTOM OPTIONS TO INCLUDE BLACK GALVANNEALED STEEL PARTS OR AREAS.

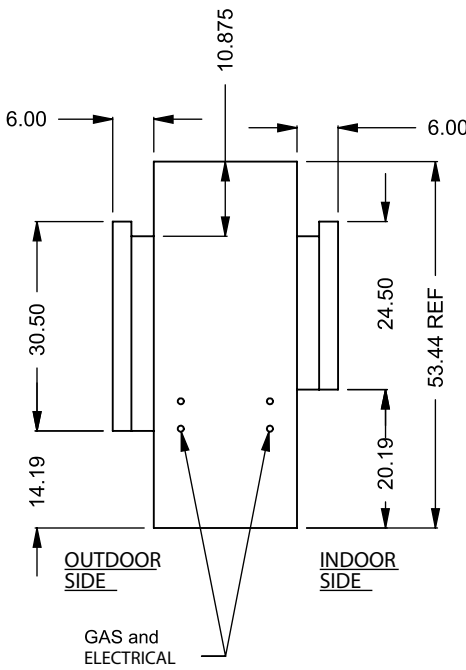
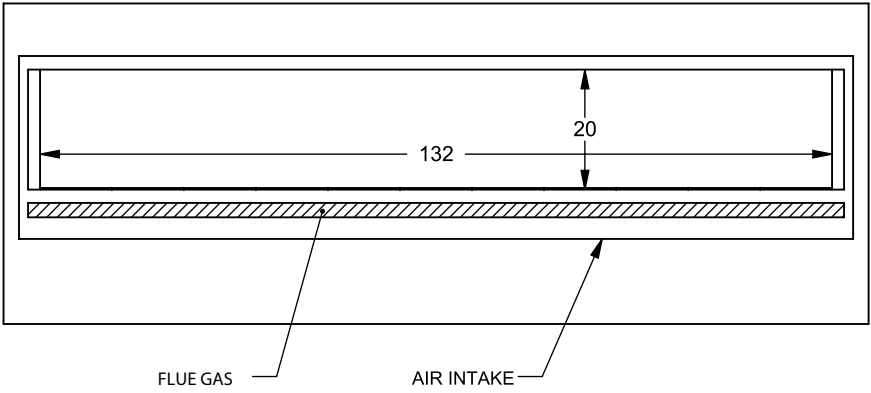
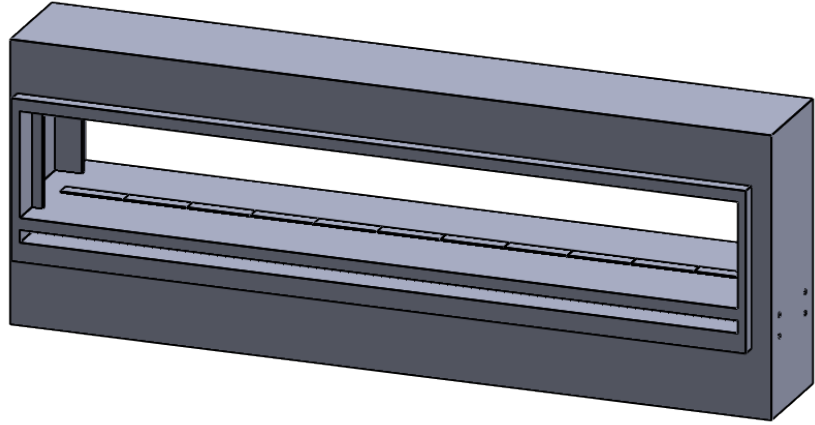
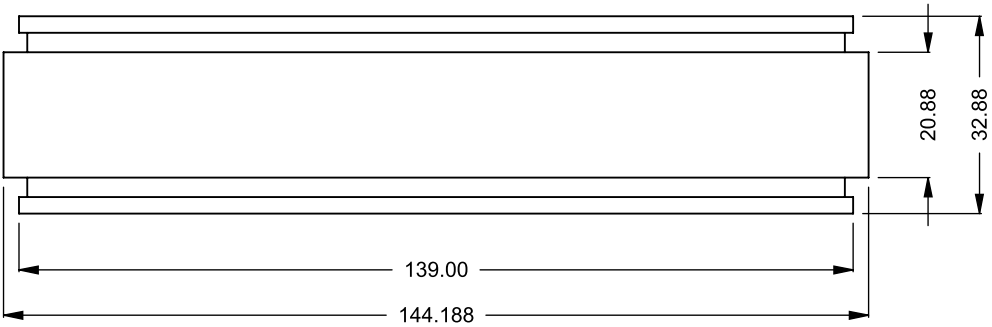

C1120STIO
Power COOL-Pack
Front Intake

**PRELIMINARY
DRAWING ONLY**

EXAMPLE CONFIGURATION	UNLESS OTHERWISE SPECIFIED	DATE
MONTIGO COMMERCIAL FIREPLACES ARE CUSTOM BUILT FOR EACH PROJECT. THIS DRAWING IS FOR REFERENCE ONLY. FLUE AND AIR INTAKE SIZES ARE SUBJECT TO CHANGE DEPENDING ON VENT RUN.	DIMENSIONS ARE IN INCHES TOLERANCES: FRACTIONAL $\pm 1/8"$	15/10/2020

MONTIGO
the art of **fireplaces**
www.montigo.com